

LNVA_24-20

Low noise voltage Amplifier

The LNVA_24-20 is a very low noise voltage amplifier, designed for many different applications where a very high impedance is required. It can be used as a buffer in natural radio signal reception, to interface the high and capacitive impedance of stylus or aerial antenna to medium impedance of LINE input in a classical sound blaster cards.



LNVA 24-20 Specifications:

Frequency range	1Hz-20kHz
Selectable Gain	0/12/24dB
Low Pass Filter	100Hz/20kHz
Power	12V-20mA
Input Impedance	10MΩ
Output Impedance	600 Ω
Input Voltage noise	0.4μV/√Hz-2
Noise Figure	0.1dB@1kHz

With this single device, connected between the antenna and the audio card, you can transform your portable PC or your desktop in a device able to receive natural signals as whistlers and tweeks, and artificial emission at very low frequencies, like signals directed to submerged submarine and Schumann resonances.

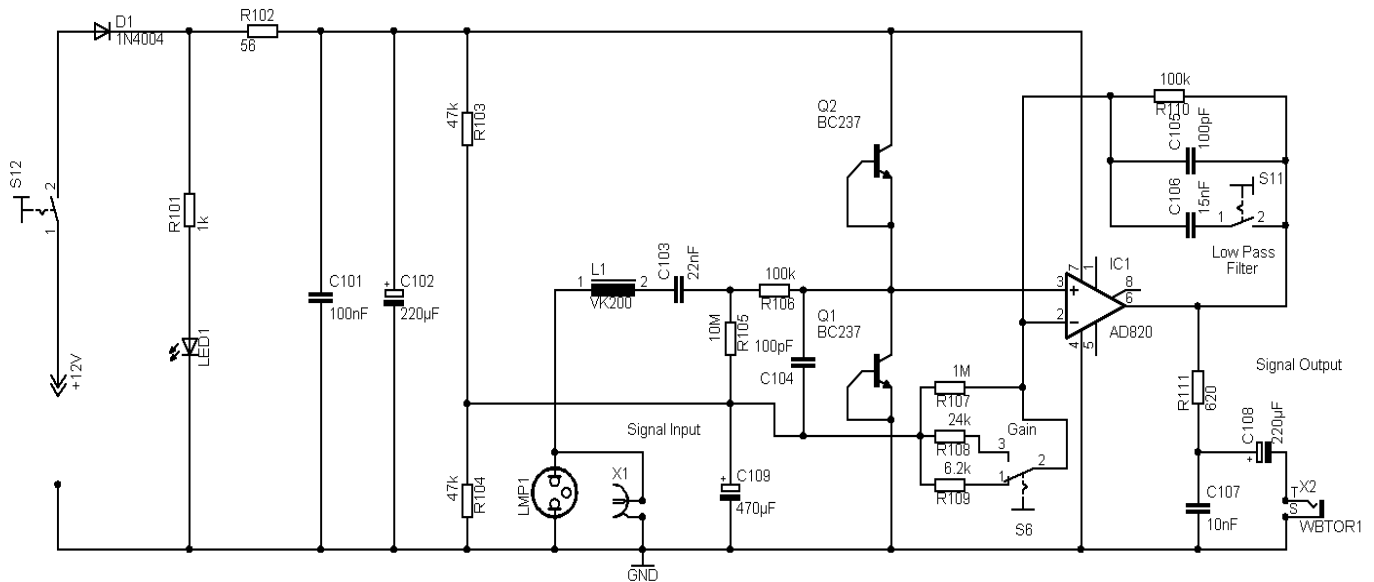

This is the simply electric schematic: the core of the circuit is the AD820, the operational amplifier of Analog Device with a very low noise current of 0.8 pA. This circuit performs, coupled with the 10 MΩ input resistance, a really very low noise amplifier device, with a noise figure better than 0.1 dB.

Particularity of this amplifier are the high input impedance (10 MΩ), a very low noise figure and an high environmental shielding. These specifications allow it's use with big aerial antenna and with a short wip both with good performance.

You can use this device in your house also, near the PC, where the hum noise is very high (the antenna must be place far from electric lines). The box is an aluminium case, treated with an anchoring base, and painted with professional enamel acrylic paint.

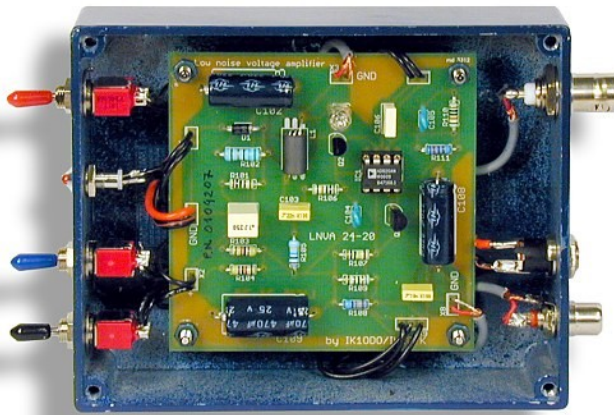

On the receiver are placed the Gain Control: 0, 12 and 24 dB, for best matching aerial antenna or short wip with the audio card sensitivity. A low pass filter with frequency cut over 100 Hz has been added, to give better conditions when you use this device for very low frequency signals reception, like Schumann resonances.

In this picture you can have a look at PCB circuit and the connections inside the box.

THE NOISE FIGURE

The LNVA_24-20 has been developed with the object of a very low noise device. The really low figure noise of 0.1 dB has been obtained by the use of a particular integrated circuit, made by Analog device: the AD820, a precision low power FET input. Consider that it performs an incredible low input current noise of 0.8 fA/sqrtHz (fempto Amperes), that with a relatively low input voltage noise of 16 nV/sqrtHz, makes this device one of the best for this particularly kind of application.

Input noise find its origin in three sources:

- a) the thermal noise of the input resistance, here of 10 Mohm. Its value can be calculated in nV/sqrtHz as $4 \times \sqrt{\text{input resistance in k}\Omega}$. Here we have: $4 \times \sqrt{10000} = 400 \text{ nV/sqrtHz}$
- b) the voltage noise of the operational amplifier, for the AD820 16 nV/sqrtHz
- c) the voltage noise generated by the current noise on the input resistance. Here a current of 0.8 fA flowing on a 10 Mohm resistance, then a voltage of 8 nV/sqrtHz.

Noise figure can be theoretically calculated as the report between the thermal noise, and the vector addition of thermal noise, voltage noise and voltage noise inducted by current noise. Here we have $400.40 / 400 \text{ nV} = 1.001$
 Calculated in dB: $NF = 20 \log 1.001 = 0.008 \text{ dB @1kHz}$ and of 0.03 dB @10Hz
 We can reasonably assume to find in a real situation a Noise Figure below 0.1 dB.

What happens to the NF value using different operational amplifier with a so high input impedance? Here you see a bries values with most commune devices:

- AD820 Theoretically Noise Figure @1kHz with 10 Mohm impedance = 0.01 dB
- TL081 Theoretically Noise Figure @1kHz with 10 Mohm impedance = 0.28 dB
- OP07 Theoretically Noise Figure @1kHz with 10 Mohm impedance = 10.00 dB
- OP27 Theoretically Noise Figure @1kHz with 10 Mohm impedance = 20.04 dB

CHARACTERIZATION CURVES AND THEORETICAL FREQUENCY RESPONSE

Here below the frequency response with LNVA used as voltage amplifier with a theoretic voltage source (then with a low impedance). The output was read with no terminated load (an oscilloscope with 1 Mohm probe). If you use a typical load (600 Ohm) to reduce the output value of 3 dB. All the graph reported in this data sheets has been really measured on a single receiver takes as reference: if you need a personal calibration please contact me at contact@vlf.it.

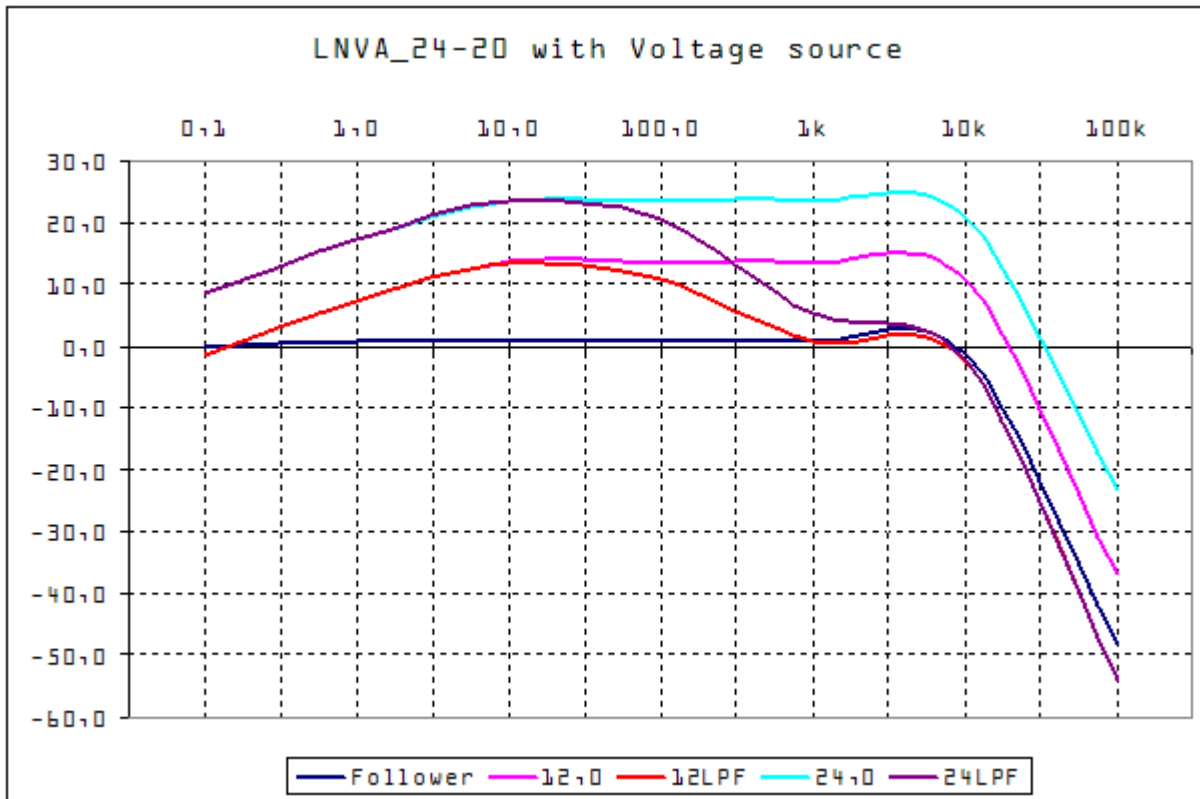

Follower trace reports the gain with 0 db gain
12dB trace reports the gain with 12 dB gain
12LPF trace reports the gain with 12 dB gain and low pass filter
24dB trace reports the gain with 24 dB gain
24LPF trace reports the gain with 24 dB gain and low pass filter

HOW TO USE THIS and FOLLOWING GRAPHS

For example: the light blue trace reports @1kHz a value of 24 dB. What does it mean?

Setting the amplifier at 24dB gain, and reading an output voltage at 1 kHz of 0.1V (with an high impedance device as an oscilloscope or a multimeter), the signal input, received from your antenna, will be the output value less the gain factor.

Numerically: $0.1V - 24dB$, then $0.1 / 15.85 = 0.0063 V$.

Using an antenna, if you know the parameters as stylus capacity and cable capacity, you can determine the voltage strength field. If the output is terminated to a typical 600 Ohm resistance you need to subtract 3 dB from the curve value.

If you use a 1m stylus the received field will be directly read in V/m. If the antenna will be of 2m you need to subtract from the curve factor a value of 3 dB, if the antenna is a vertical wip of 10m you need subtract a value of 20 dB, and so on.

PRACTICAL FREQUENCY RESPONSE USING REAL ANTENNAS

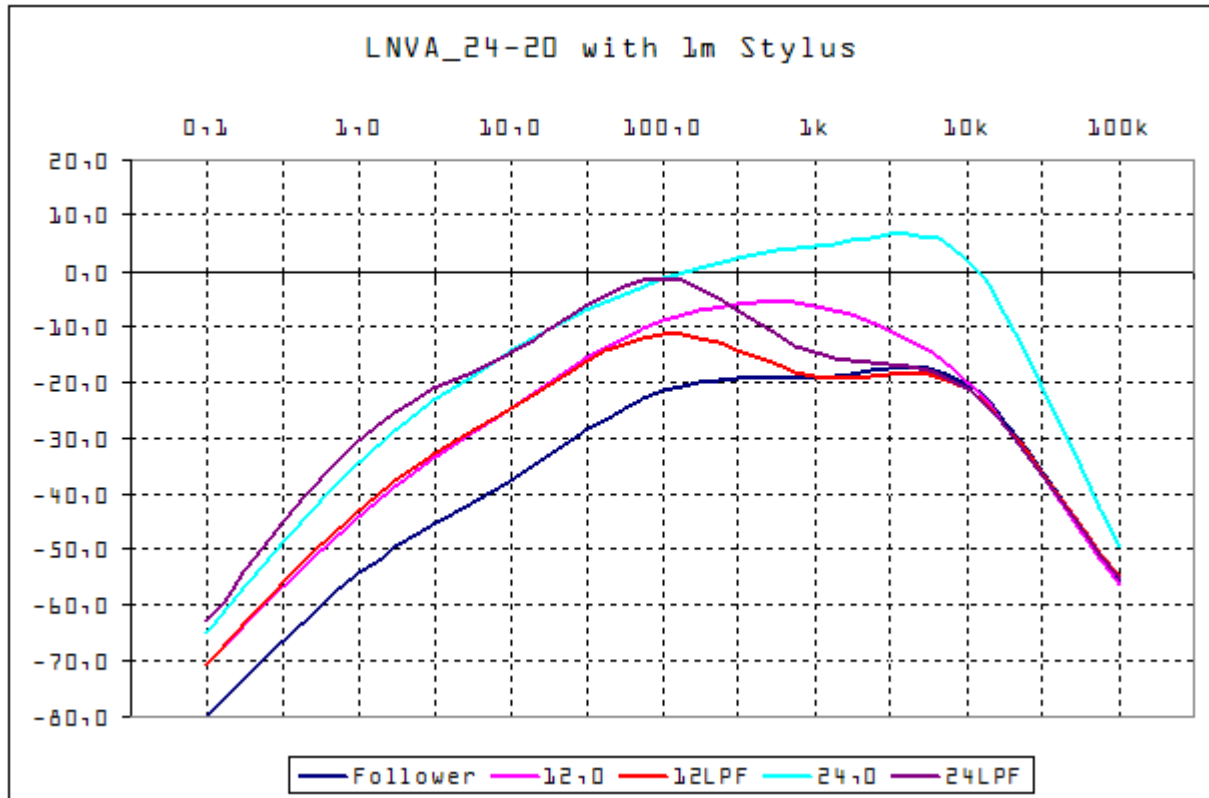

Here there are the characterization curves of the LNVA_24-20 using a 1m stylus placed directly on the receiver. Measures have been done in a reason of a 18 pF equivalent capacity.

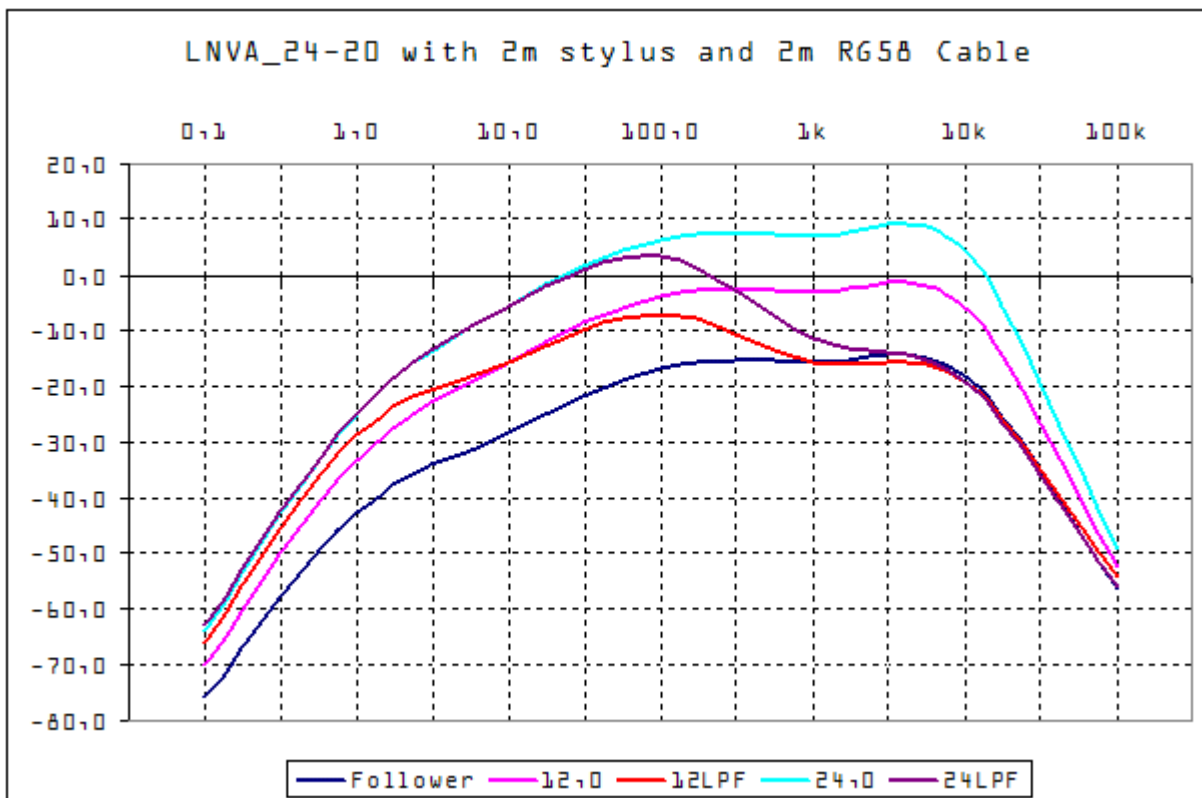

Here there are the characterization curves of the LNVA_24-20 using a 2m stylus connected with 2m of RG58 cable to the receiver. Measures have been done in a reason of a 30 pF equivalent stylus capacity and 195 pF from cable.

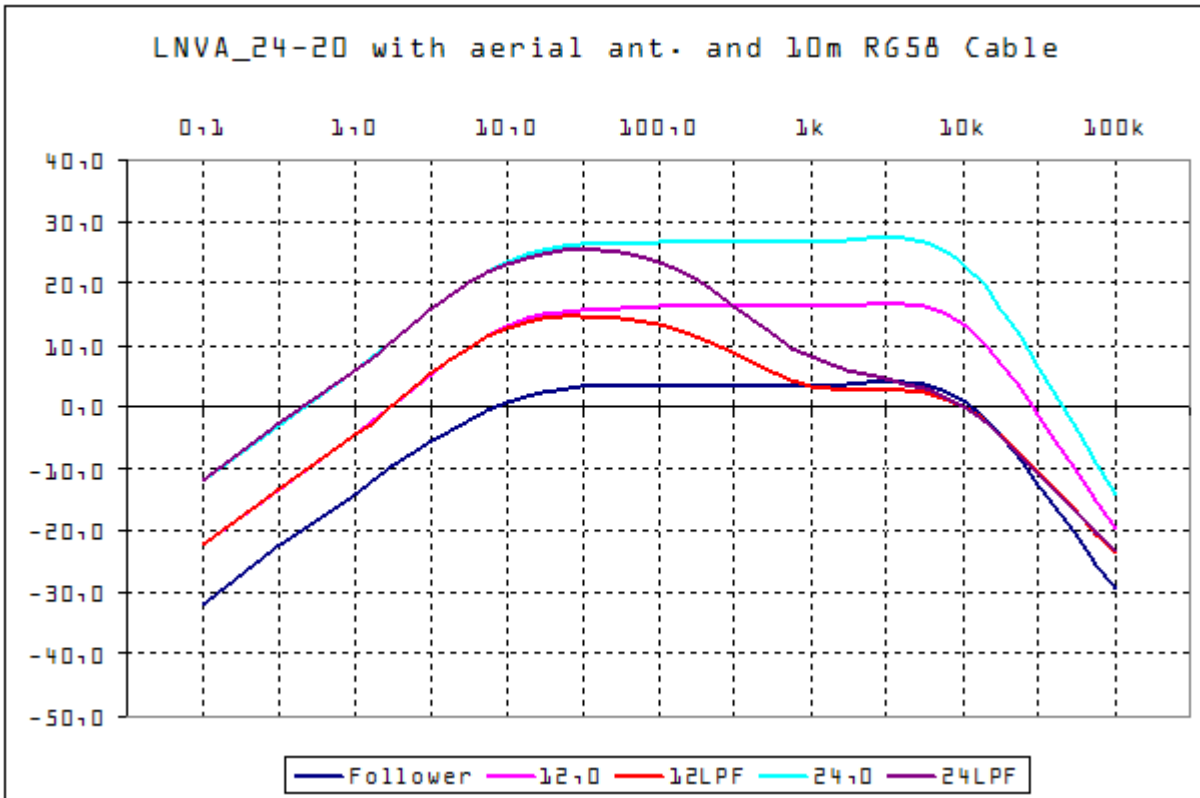

Here there are the characterization curves of the LNVA_24-20 using an aerial wire antenna connected with 10m of RG58 cable to the receiver. Measures have been done in a reason of a 195 pF equivalent antenna capacity and 1000 pF from cable.

- Follower trace reports the gain with 0 db gain
- 12,0 trace reports the gain with 12 db gain
- 12LPF trace reports the gain with 12 db gain and low pass filter
- 24,0 trace reports the gain with 24 db gain
- 24LPF trace reports the gain with 24 db gain and low pass filter

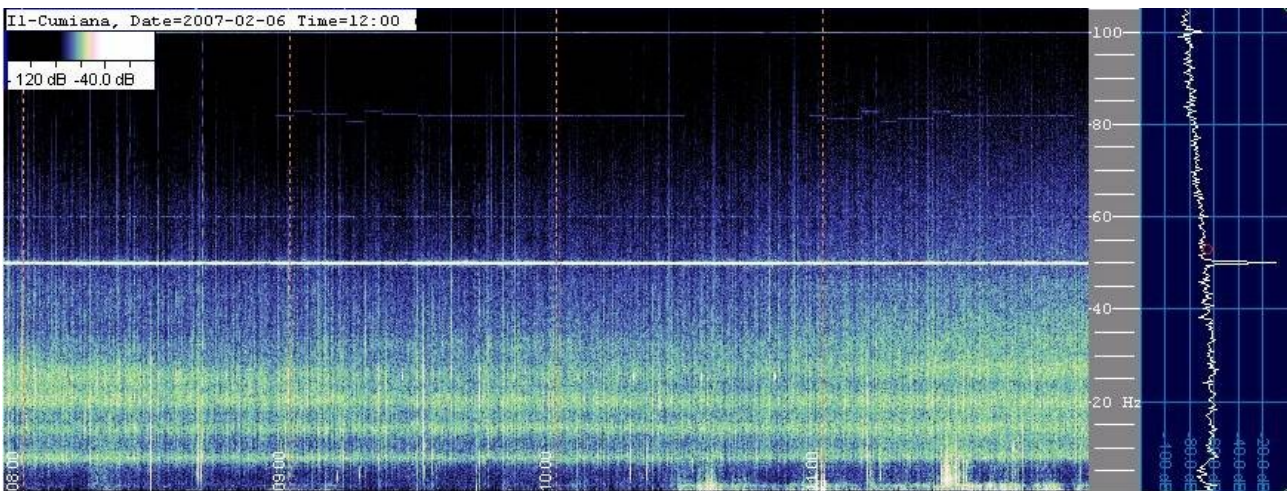

This spectrogram reports a reception with a 45m long wire, connected to the LNVA_24-20 with 50m of RG58 coaxial cable. Schumann resonances are clear and strong, as for the two pattern of 82 Hz submarine signals.

COMPARISON BETWEEN DIFFERENT ANTENNAS

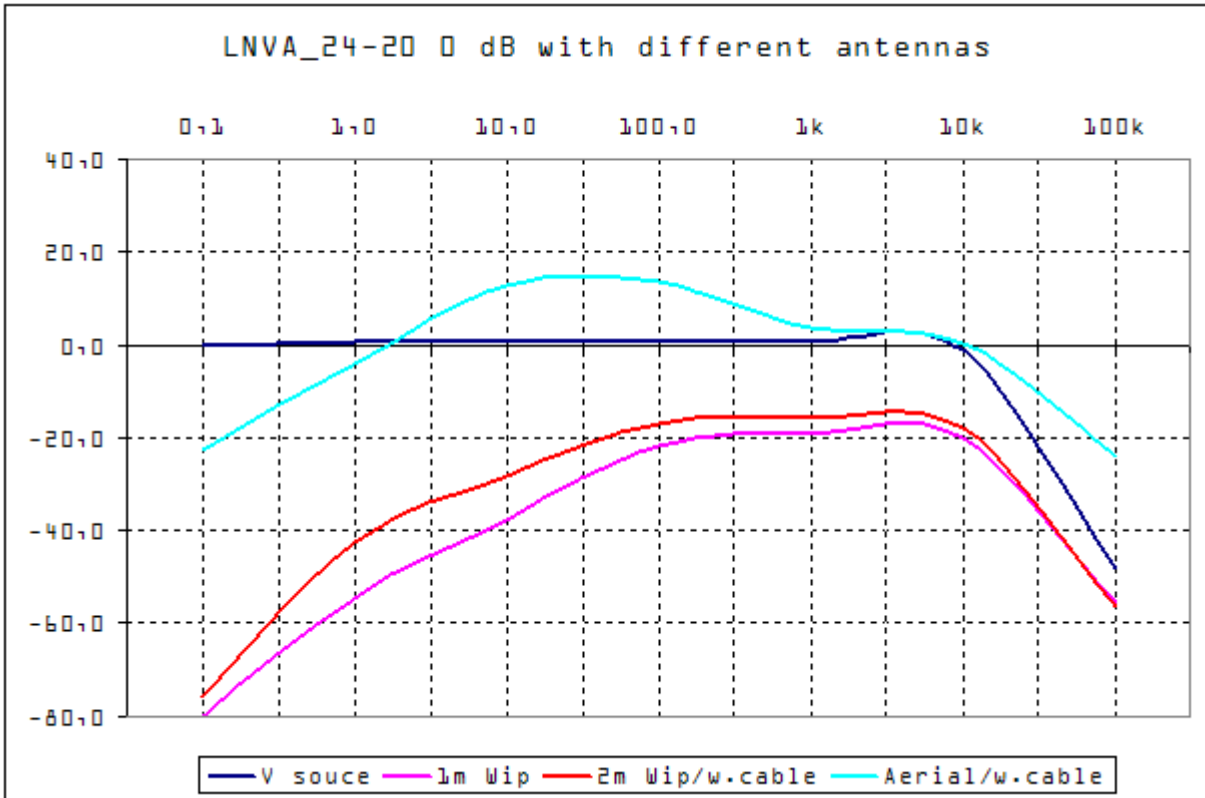

Here there are the characterization curves of the LNVA_24-20 set as a follower (0 dB Gain) with different antennas.

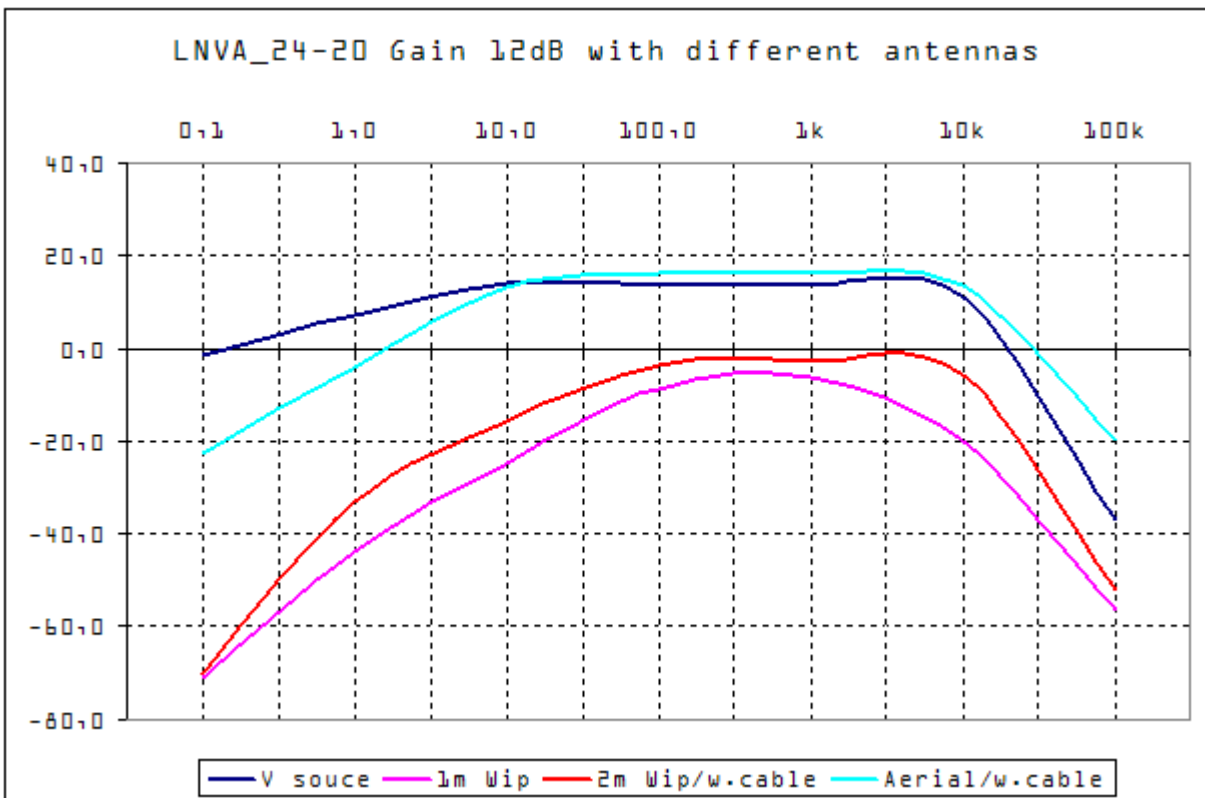

Here there are the characterization curves of the LNVA_24-20 set with gain of 12 dB with different antennas.

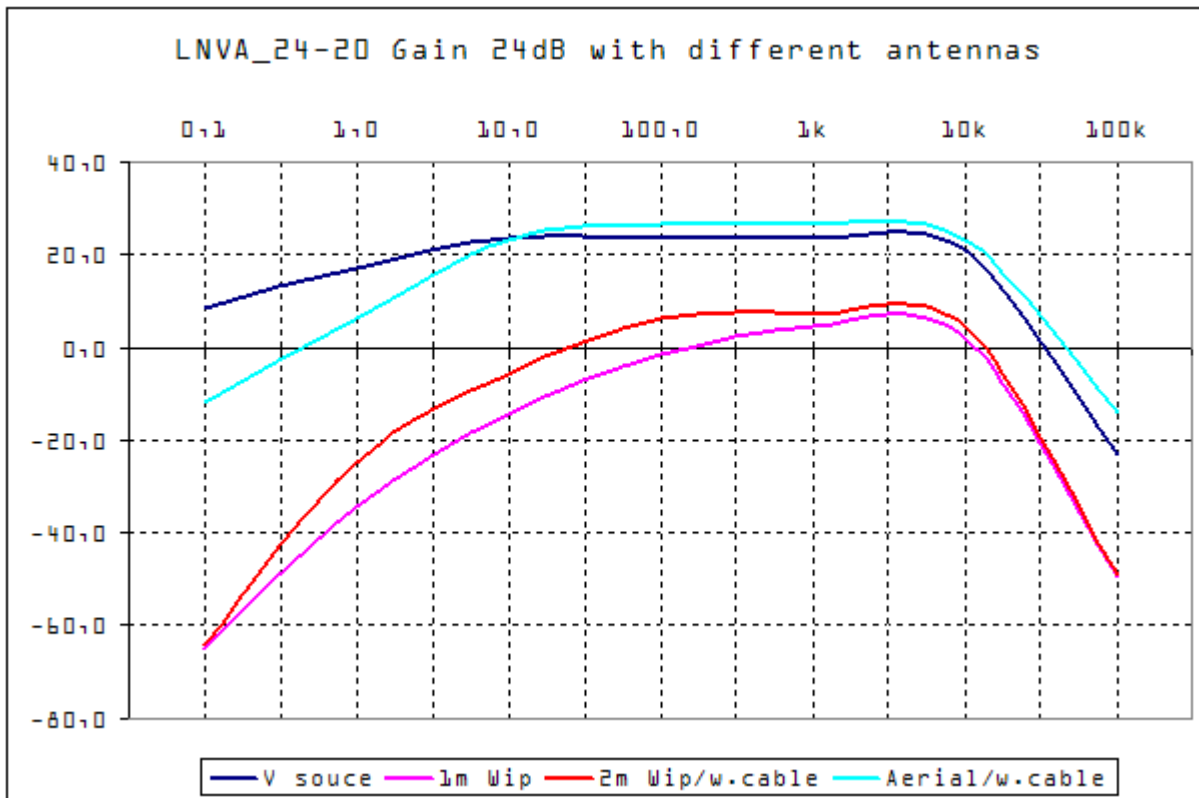

Here there are the characterization curves of the LNVA_24-20 set with gain of 24 dB with different antennas.

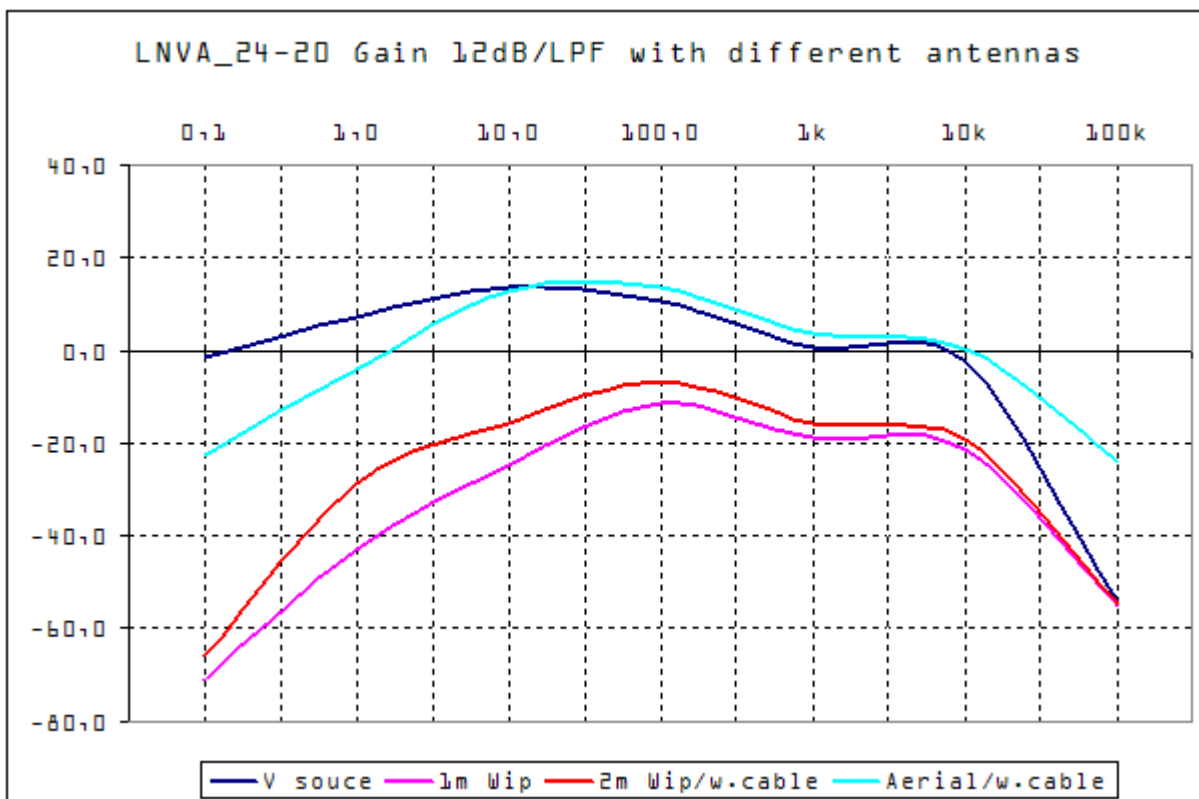

Here there are the characterization curves of the LNVA_24-20 set with gain of 12 dB and 100 Hz low pass filter with different antennas.

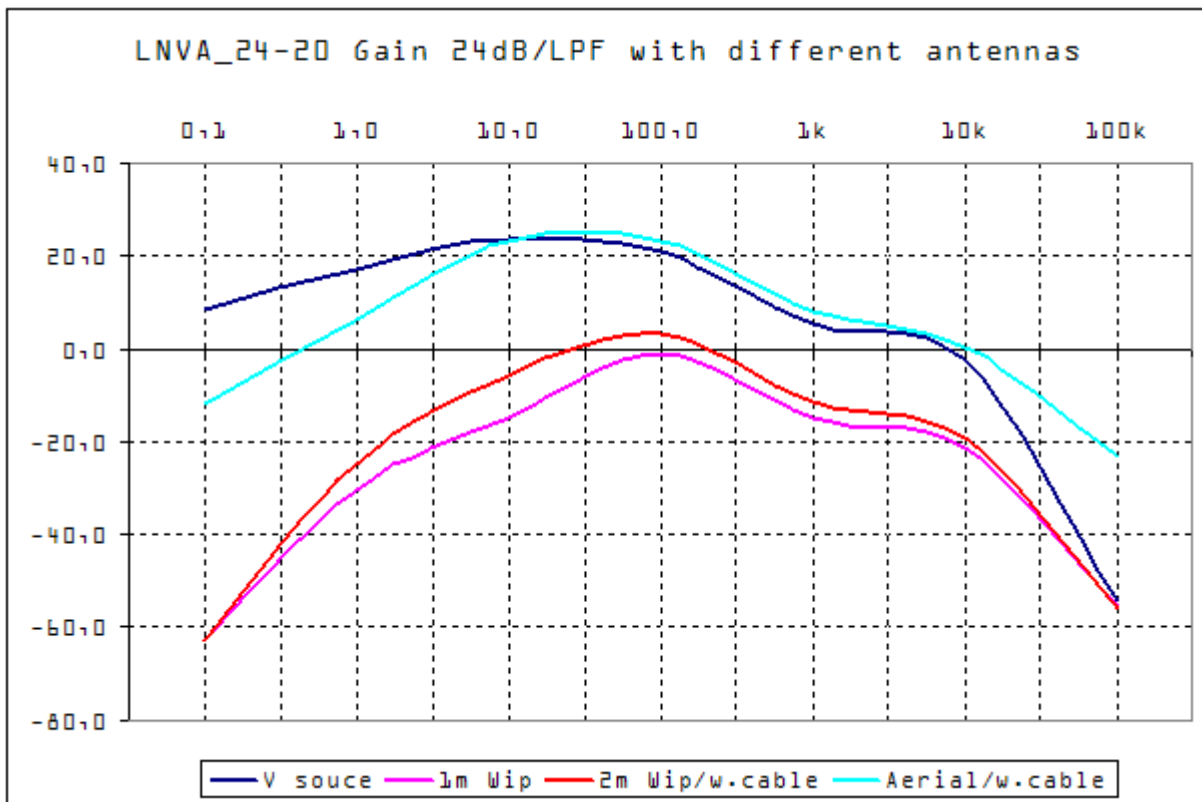

Here there are the characterization curves of the LNVA_24-20 set with gain of 24 dB and 100 Hz low pass filter with different antennas.

Follower trace reports the gain with 0 db gain
 12.0 trace reports the gain with 12 dB gain
 12LPF trace reports the gain with 12 dB gain and low pass filter
 24.0 trace reports the gain with 24 dB gain
 24LPF trace reports the gain with 24 dB gain and low pass filter

APPLICATIONS AND GENERAL NOTES

This device can be used as Natural Radio Signals receiver, and in general for VLF band, with different kind of antenna_

- a simply stylus placed directly on the BNC connection of the LNVA_24-20, like a CB antenna placed on the car roof.
- a stylus fixed on the ground, and connected to the receiver with a coaxial cable (don't exceed the cable length)
- a big aerial wire antenna (or a long wire) connected to the receiver with a coaxial cable (this configuration supports also long cable, more than 20mt)

This device doesn't work properly with low impedance antennas like loop antennas: they require a very low input impedance (or a virtual short circuit). Using the LNVA_24-20 preamplifier with a loop with an impedance of 1 kOhm we obtain a bad Noise figure, greater than 12.3 dB.

!!! WARNING !!!

**Be carefull! Aerial antennas are electrically "HOT". Electrostatic voltage can damage the connected devices and be dangerous for users.
 Don't use in storming weather.**